

**62.42
PSRU**

Закладная опора регулируемая типа U

????????????? ??????
+48 58 55 40 410

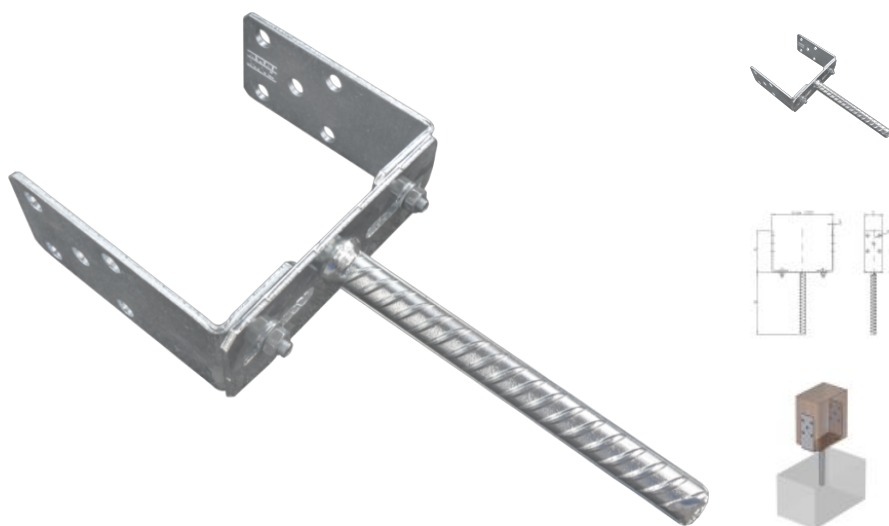

????????? (?????????):

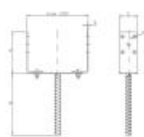

B
ЦИНКОВОЕ
ПОКРЫТИЕ
В БЕЛОМ ЦВЕТЕ

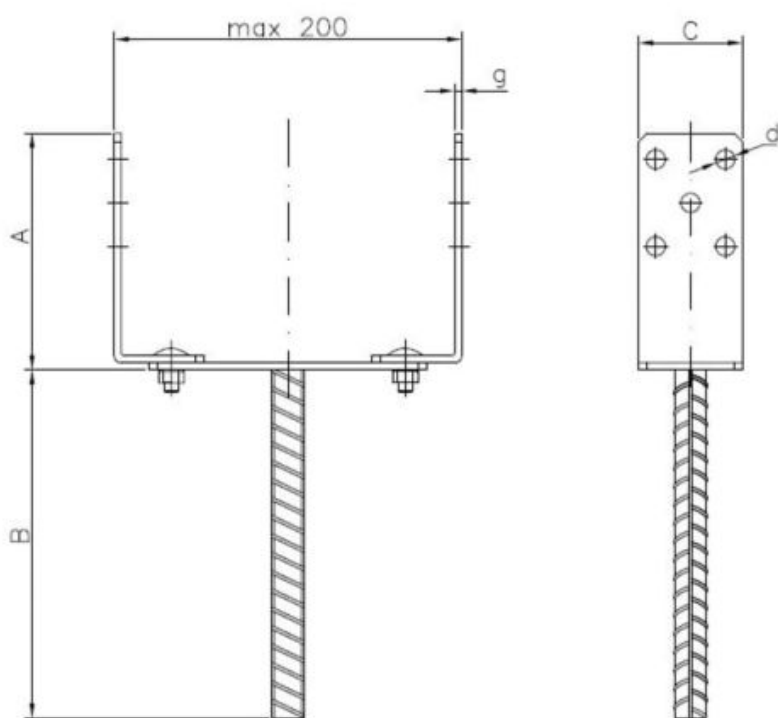

????????

Material index	A [mm]	B [mm]	C [mm]	d [mm]
6242PSRU060120320S	120	200	60	5 x Ø11
6242PSRU060136336S	136	200	60	5 x Ø11