

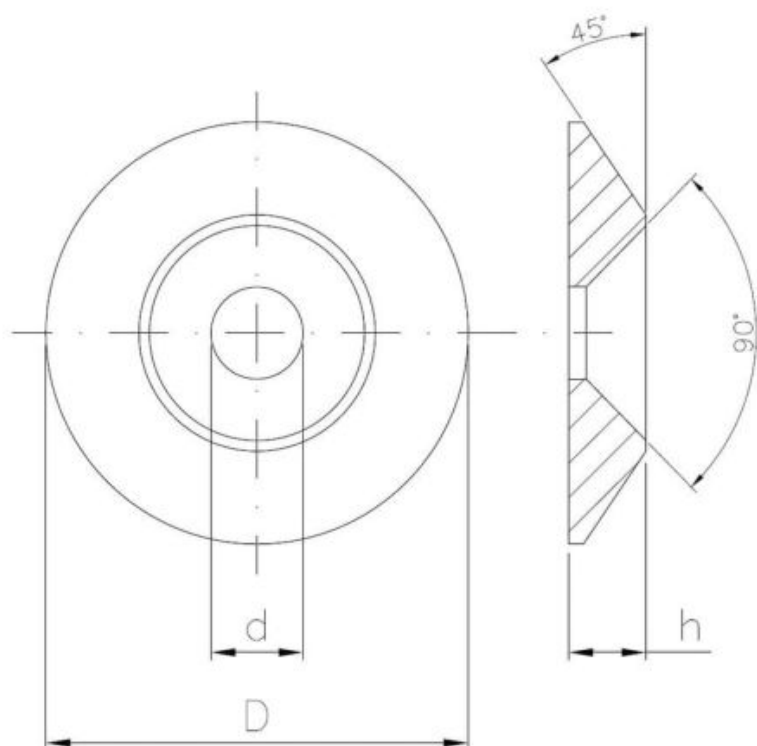

????????? (?????????):



????????

Material index	d [mm]	D [mm]	h [mm]	Вид покрытия
1431100300AT	10.5	30.0	6.6	A (цинковое покрытие в желтом цвете)
1431080245AT	8.5	24.5	5.4	A (цинковое покрытие в желтом цвете)
1431060195AT	7.5	19.5	4.6	A (цинковое покрытие в желтом цвете)