

????????? (?????????):

A
ЦИНКОВОЕ
ПОКРЫТИЕ
В ЖЕЛТОМ ЦВЕТЕ

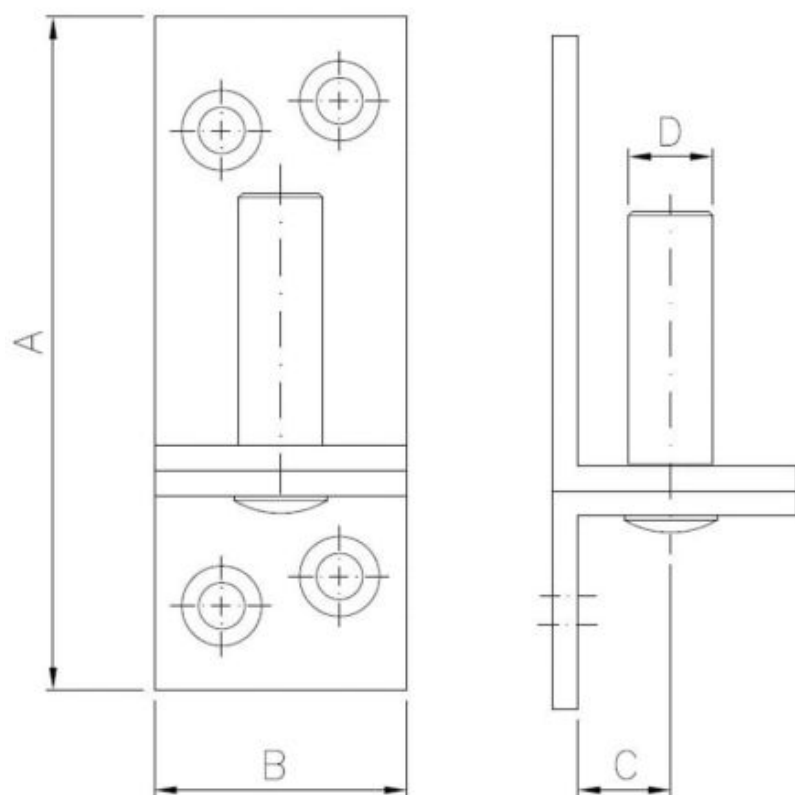

???????

Material index	A [mm]	B [mm]	C [mm]	D [mm]
6822130025016AS	130	40	25	16
6822120011016AS	120	40	11	16
6822104011013AS	104	35	11	13
6822104025013AS	104	35	25	13
6822081011010AS	81	30	11	10
6822086025010AS	86	30	25	10