

63.22 Скоба соединительная

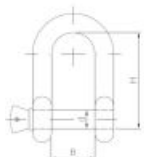

???????? (????????):

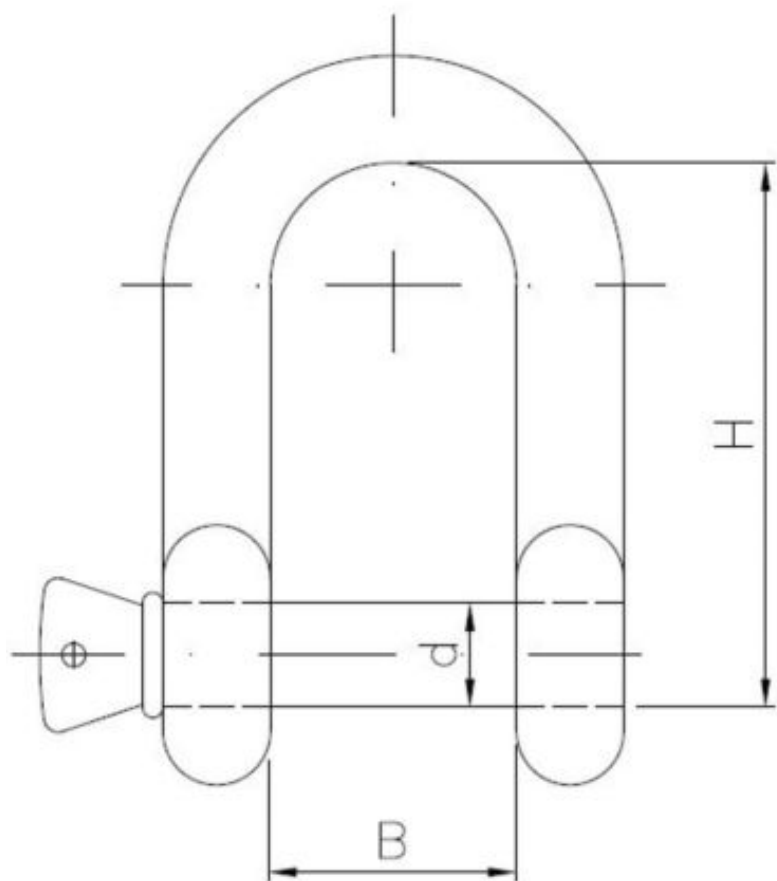

???????????????? ???? ???? ?

+48 58 55 40 410

Standards:

DIN 82101

B

ЦИНКОВОЕ
ПОКРЫТИЕ
В БЕЛОМ ЦВЕТЕ

????????

Material index	d [mm]	B [mm]	H [mm]	Obciążenie dopuszczalne [kg]
6322280S	28.0	56	106	3000
6322220S	22.0	44	82	1500
6322200S	20.0	38	76	1100
6322180S	18.0	36	71	950
6322160S	16.0	32	63	800

Material index	d [mm]	B [mm]	H [mm]	Obciążenie dopuszczalne [kg]
6322140S	14.0	28	56	650
6322120S	12.0	25	48	520
6322100S	10.0	20	40	320
6322080S	8.0	16	32	200
6322060S	6.0	12	24	100
6322050S	5.0	10	20	70