

?????????????? ??????

+48 58 55 40 410

Standards:

ETA-16/0716



B

ЦИНКОВОЕ
ПОКРЫТИЕ
В БЕЛОМ ЦВЕТЕ

????????? (?????????):

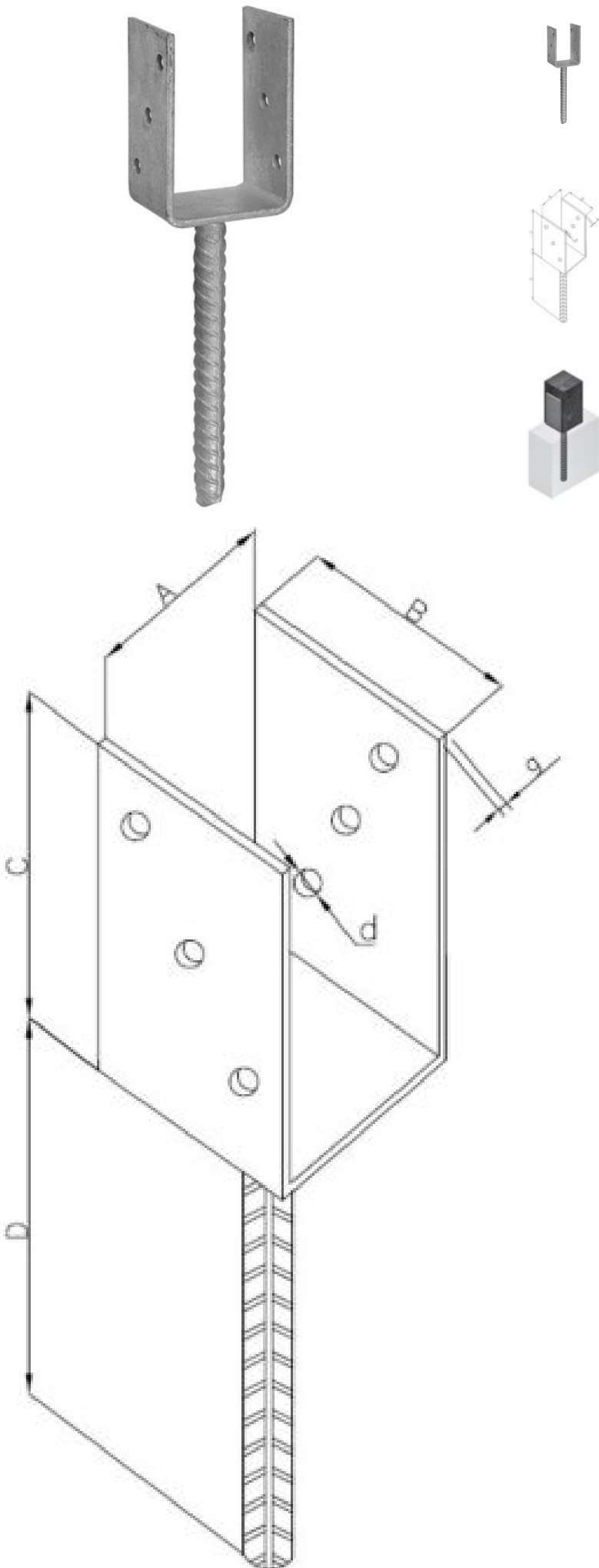

???????

Material index	Oznaczenie	A [mm]	B [mm]	C [mm]	D [mm]	d [mm]
6231PS02070060120S	PS2	70	60	120	16 x 200	6 x Ø11
6231PS03080060120S	PS3	80	60	120	20 x 200	6 x Ø11
6231PS04090060120S	PS4	90	60	120	20 x 200	6 x Ø11
6231PS01060060120S	PS1	60	60	120	16 x 200	6 x Ø11
6231PS05100060120S	PS5	100	60	120	20 x 200	6 x Ø11
6231PS06120060120S	PS6	120	60	120	20 x 200	6 x Ø11
6231PS08140060126S	PS8	140	60	120	20 x 200	6 x Ø11